

M4 x 6 脱落防止ねじ (ユニクロメッキ品)

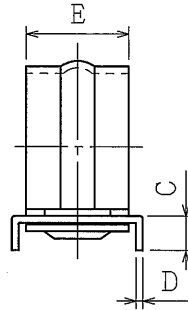

付属 AYプラグ × 1  
プラグボルトM5 (ユニクロメッキ品)

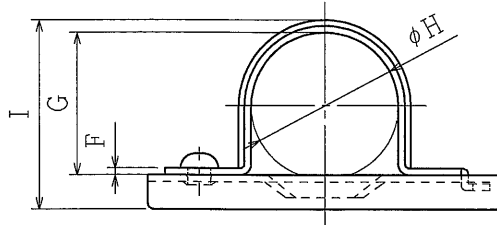

SA-16, 19, 22, 25, 28, 31, 36, 39, V16

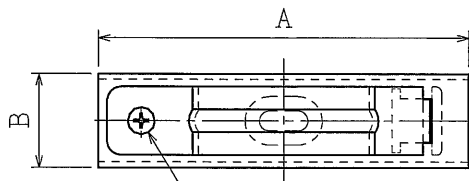

M5 x 8 脱落防止ねじ (ユニクロメッキ品)



付属 AYプラグ × 1  
プラグボルトM6 (ユニクロメッキ品)

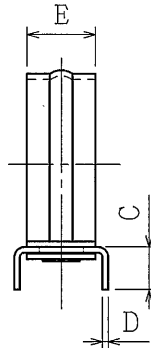
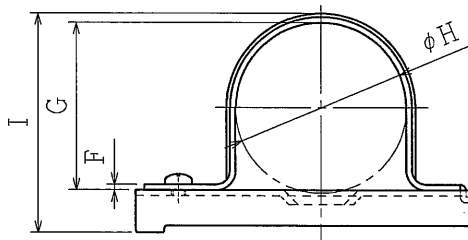

SA-42, 51

サドルエース (電気めっき仕様)

|      | 品番      | A   | B  | C  | D   | E  | F   | G    | H    | I    |
|------|---------|-----|----|----|-----|----|-----|------|------|------|
| 薄鍍用  | SA-19E  | 56  | 23 | 6  | 1.2 | 18 | 1.2 | 18.5 | 19.4 | 26.7 |
|      | SA-25E  | 62  | 23 | 6  | 1.2 | 18 | 1.2 | 24.6 | 25.7 | 32.8 |
|      | SA-31E  | 68  | 25 | 6  | 1.2 | 20 | 1.2 | 30.9 | 31.8 | 39.4 |
|      | SA-39E  | 80  | 25 | 6  | 1.6 | 24 | 1.6 | 37.7 | 38.2 | 46.1 |
|      | SA-51E  | 120 | 33 | 15 | 2   | 24 | 2   | 49.7 | 50.1 | 68.0 |
| 厚鍍用  | SA-16E  | 56  | 23 | 6  | 1.2 | 18 | 1.6 | 20.4 | 20.8 | 29.0 |
|      | SA-22E  | 62  | 23 | 6  | 1.2 | 18 | 1.6 | 26.0 | 27.0 | 34.2 |
|      | SA-28E  | 68  | 25 | 6  | 1.2 | 20 | 1.6 | 32.3 | 33.9 | 40.9 |
|      | SA-36E  | 80  | 25 | 6  | 1.6 | 24 | 1.6 | 41.5 | 42.5 | 50.1 |
|      | SA-42E  | 120 | 33 | 15 | 2   | 24 | 2   | 46.4 | 47.9 | 64.9 |
| VE管用 | SA-V16E | 56  | 23 | 6  | 1.2 | 18 | 1.6 | 21.5 | 22.0 | 30.1 |

|             |       |
|-------------|-------|
| 品番          |       |
| 材質          | SPCC  |
| 表面処理<br>又は色 | 電気めっき |
| 備考          |       |

|          |                     |   |    |
|----------|---------------------|---|----|
| 品名       | サドルエース<br>(電気めっき仕様) |   | 尺度 |
| 図番       | Z03-1028-A01        | △ | /  |
| 日動電工株式会社 |                     |   |    |

1

2

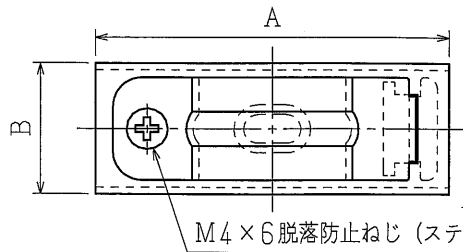

付属 AYプラグ × 1  
プラグボルトM5 (ステンレス品)

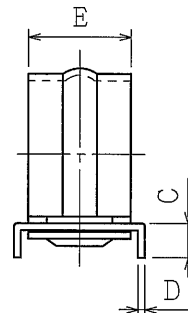
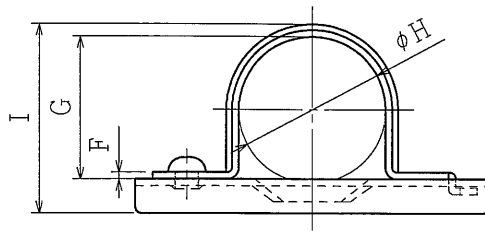

SA-16, 19, 22, 25, 28, 31, 36, 39, V16

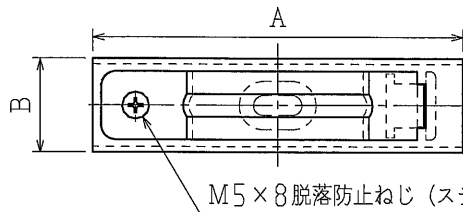

付属 AYプラグ × 1  
プラグボルトM6 (ステンレス品)

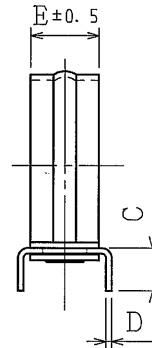
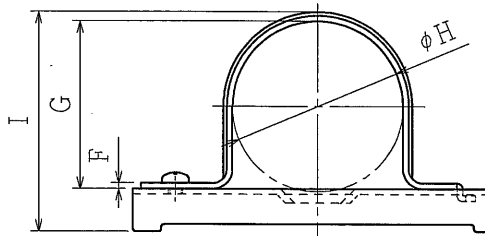

SA-42, 51, 54, 70

サドルエース (ステンレス仕様)

|      | 品番      | A   | B  | C  | D   | E  | F   | G    | H    | I    |
|------|---------|-----|----|----|-----|----|-----|------|------|------|
| 薄銅用  | SA-19S  | 56  | 23 | 6  | 1.2 | 18 | 1.2 | 18.5 | 19.4 | 26.7 |
|      | SA-25S  | 62  | 23 | 6  | 1.2 | 18 | 1.2 | 24.6 | 25.7 | 32.8 |
|      | SA-31S  | 68  | 25 | 6  | 1.2 | 20 | 1.2 | 30.9 | 31.8 | 39.4 |
|      | SA-39S  | 80  | 25 | 6  | 1.5 | 24 | 1.5 | 37.7 | 38.2 | 46.1 |
|      | SA-51S  | 120 | 33 | 15 | 2   | 24 | 2   | 49.7 | 50.1 | 68.0 |
| 厚銅用  | SA-16S  | 56  | 23 | 6  | 1.2 | 18 | 1.5 | 20.4 | 20.8 | 29.0 |
|      | SA-22S  | 62  | 23 | 6  | 1.2 | 18 | 1.5 | 26.0 | 27.0 | 34.2 |
|      | SA-28S  | 68  | 25 | 6  | 1.2 | 20 | 1.5 | 32.3 | 33.9 | 40.9 |
|      | SA-36S  | 80  | 25 | 6  | 1.5 | 24 | 1.5 | 41.5 | 42.5 | 50.1 |
|      | SA-42S  | 120 | 33 | 15 | 2   | 24 | 2   | 46.4 | 47.9 | 64.9 |
|      | SA-54S  | 130 | 33 | 15 | 2   | 24 | 2   | 58.3 | 60.0 | 76.5 |
|      | SA-70S  | 150 | 33 | 15 | 2   | 24 | 2   | 74.3 | 75.8 | 92.5 |
| VE管用 | SA-V16S | 56  | 23 | 6  | 1.2 | 18 | 1.5 | 21.5 | 22.0 | 30.0 |

|             |           |
|-------------|-----------|
| 品番          |           |
| 材質          | SUS304    |
| 表面処理<br>又は色 | バレル研磨, 脱脂 |
| 備考          |           |

|  |                     |   |    |
|--|---------------------|---|----|
| 品名   | サドルエース<br>(ステンレス仕様) |   | 尺度 |
| 図番   | Z03-1028-A02        | △ | /  |
|  日動電工株式会社 |                     |   |    |

1

2

A4

A

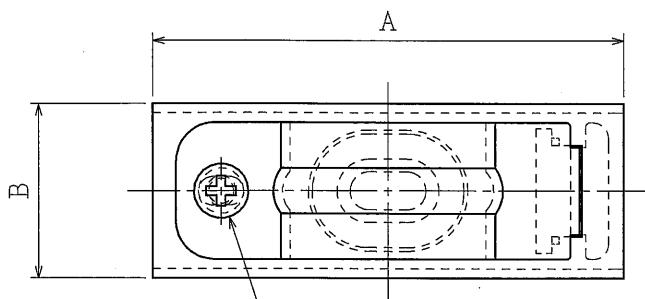

M4×6 脱落防止ねじ (ステンレス品)

A

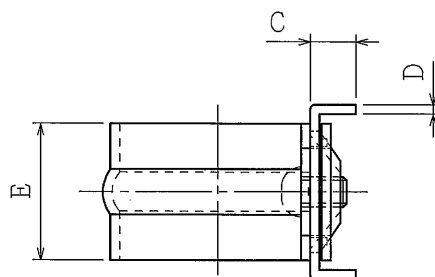

B

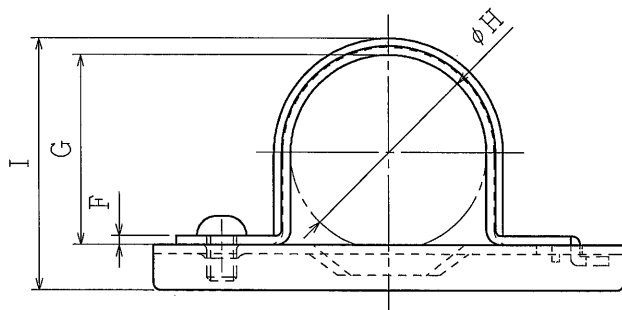

付属 AYプラグ ×1  
プラグボルトM5 (ステンレス品)

B

C

サドルエース (熔融亜鉛めっき仕様)

|             | 品番     | A  | B  | C | D   | E  | F   | G    | H    | I    |
|-------------|--------|----|----|---|-----|----|-----|------|------|------|
| 厚<br>鑑<br>用 | SA-16Z | 56 | 23 | 6 | 1.2 | 18 | 1.6 | 20.4 | 20.8 | 29.0 |
|             | SA-22Z | 62 | 23 | 6 | 1.2 | 18 | 1.6 | 26.0 | 27.0 | 34.2 |
|             | SA-28Z | 68 | 25 | 6 | 1.2 | 20 | 1.6 | 32.3 | 33.9 | 40.9 |
|             | SA-36Z | 80 | 25 | 6 | 1.6 | 24 | 1.6 | 41.5 | 42.5 | 50.1 |

C

D

|             |         |
|-------------|---------|
| 品番          |         |
| 材質          | SPCC    |
| 表面処理<br>又は色 | 熔融亜鉛めっき |
| 備考          |         |

|  |                       |   |    |
|--|-----------------------|---|----|
| 品名   | サドルエース<br>(熔融亜鉛めっき仕様) |   | 尺度 |
| 図番   | Z98-0706-3            | △ | /  |
|  日動電工株式会社 |                       |   |    |

D